

## Internal Fittings



**Shelf**  
For 110-600



**Reinforced shelf**  
For 170-910

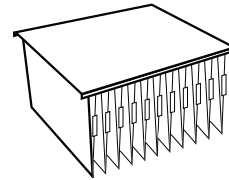

**Shelf for hanging lateral files**  
For 170-910

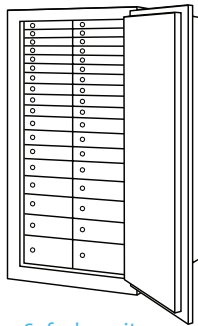

**Safe deposit locker columns**  
For 600-910

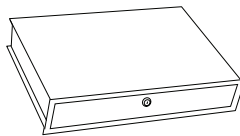

**Extendable lockable drawer**  
For 110-600

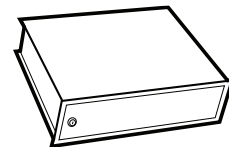

**Lockable compartment**  
For 170-420

## Customisation

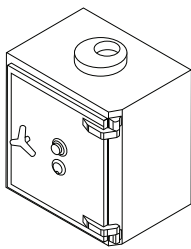

**Air tube connection**

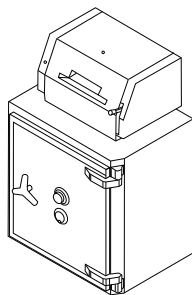

**Drum deposit safe**

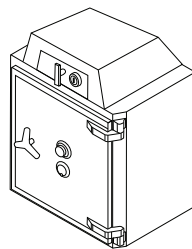

**Drawer deposit safe**

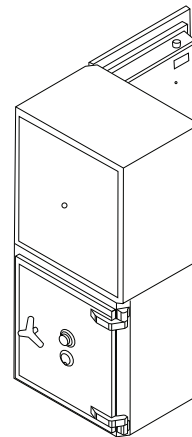

**Dual safe**

Authorised dealer

**Chubbsafes**  
*Trusted the world over.*

[www.chubbsafes.com](http://www.chubbsafes.com)

'Chubb' is owned by Chubb plc and is a registered trademark used under license

The unique Trident range not only offers strong burglary protection from Grades III to VI, but also resistance against fire and explosives to ensure maximum protection for your valuables



# Trident

BURGLARY, FIRE AND EXPLOSIVES PROTECTION

## Key Features

- The Trident range is independently certified to cover three types of risk:
  - Burglary protection in Grades III–VI. Certified by ECB•S in accordance with the stringent European standard, EN 1143-1.
  - Fire protection for documents for up to one hour. Certified NT Fire 017–60 Paper by SP.
  - Protection against explosives in Grades III–VI EX. Certified by ECB•S in accordance with the stringent European standard, EN 1143-1.
- Seven models for each grade, ranging from 111 to 907 litres in capacity.
- Wide choice of key locks, combination locks or electronic locks.
- Range of interior fittings includes shelf, shelf for hanging files, extendable lockable drawer and lockable compartment.
- Ergonomically designed to allow for full access to the safe's contents when the door is opened 90°.
- Sizes 110–210 can be fitted with an optional deposit drawer trap.
- Size 600 can be fitted with up to two columns of safe deposit lockers and size 910 with three.
- Available with the door hung on the right or the left.



**Chubb**safes  
*Trusted the world over.*

## Product Specifications

Model	External (mm)			Internal (mm)			Total depth with door(s) at 90° (mm) (G)	Total width with door(s) at 180° (mm) (H)	Volume (litres)	No. of doors
	Height (A)	Width (B)	Depth (C)	Height (D)	Width (E)	Depth (F)				
110	790	730	560	620	560	320	1205	1420	111	1
170	920	730	640	750	560	400	1285	1420	168	1
210	920	730	740	750	560	500	1385	1420	210	1
310	1270	730	740	1100	560	500	1385	1420	308	1
420	1470	810	740	1300	640	500	1465	1580	416	1
600	1850	880	740	1680	710	500	1535	1720	596	1
910	1850	1250	740	1680	1080	500	1385	2568	907	2

Model	Weight (kg)			
	Gr III	Gr IV	Gr V	Gr VI
110	540	560	595	635
170	670	695	740	790
210	745	775	825	880
310	970	1005	1075	1150
420	1180	1225	1310	1400
600	1530	1590	1695	1810
910	1990	2060	2195	2350

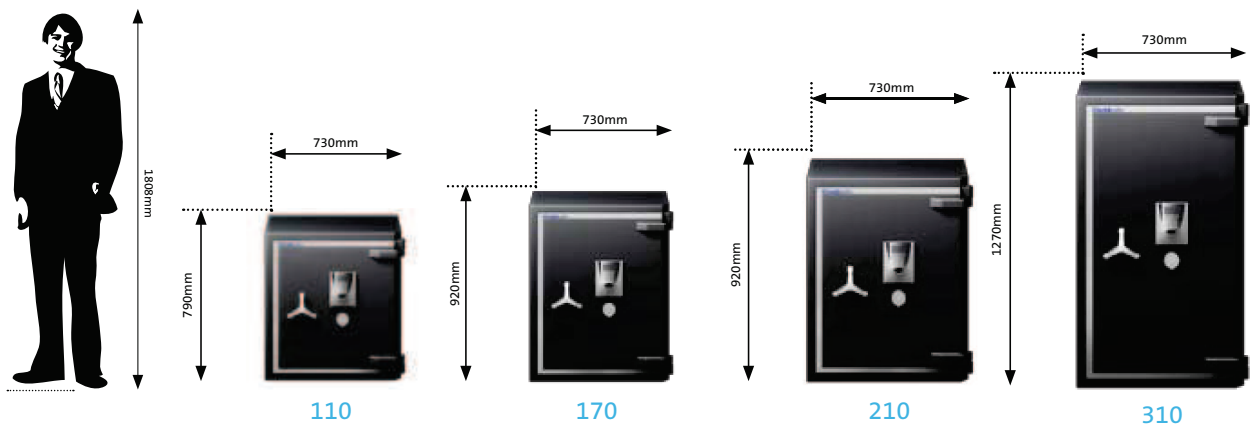
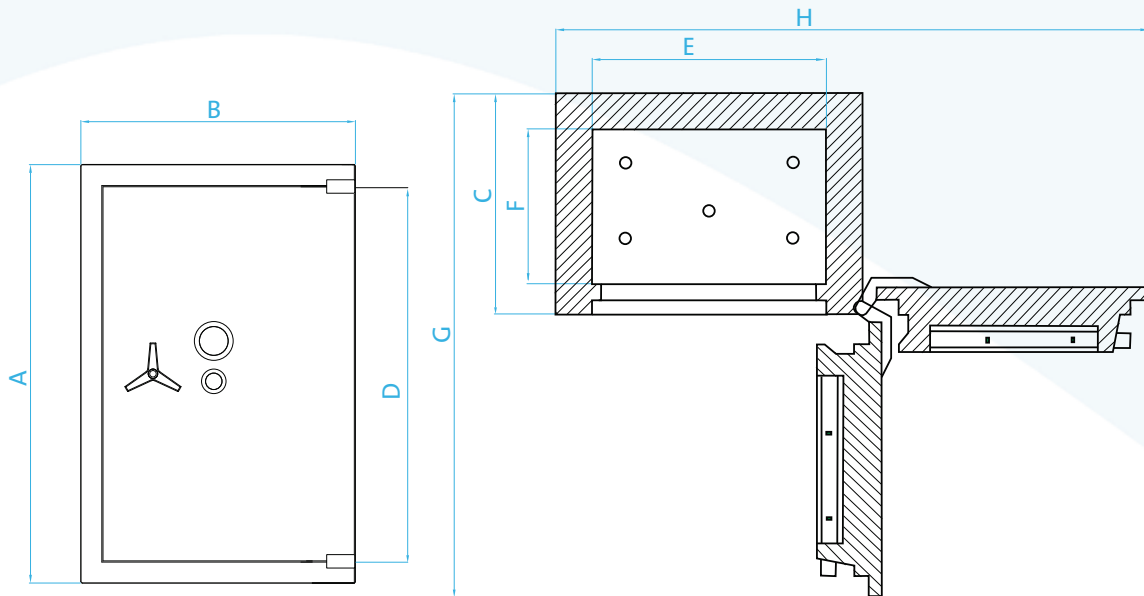

## Testing



### Burglary Certification: Grades III–VI, EN 1143-1 (ECB•S)

A range of tools typically used in burglary attempts were used to test Trident's level of resistance, from basic equipment, such as hammers and simple drills, to sophisticated thermal and electrical equipment, such as oxyacetylene torches and disc cutters.



### Explosives Certification: Grades III EX–VI EX, EN 1143-1 (ECB•S)

Trident has also been approved for resistance against explosives – a particularly high level of protection for your valuables.



### Fire Certification: NT Fire 017–60 Paper (SP)

In addition, Trident will protect documents from the effects of fire for up to one hour.

During the testing procedure, the safe was placed in a furnace and heated to temperatures around 1000°C without the documents inside sustaining any damage.

## Lock Options

A series of EN 1300 certified key locks, combination locks and electronic locks is available to choose from.

### Grade III

At least one EN 1300 Grade B lock must be fitted as standard. A second lock may be added upon customer's request.

### Grades IV & V

At least two EN 1300 Grade B locks must be fitted as standard.

### Grade VI

At least two EN 1300 Grade C locks must be fitted as standard.

As an option for all grades, a third lock may also be fitted under certain conditions.

## Other Options

- Drawer deposit for sizes 110, 170 and 210 in Grades III to V.
- SDL 2000: two columns can be fitted in model 600 and three in model 910.
- Air tube or deposit slot can be fitted on top of the safe (non-certified)
- Planar protection for connection to central alarm system. Triggers alarm if an attempt is made to drill into the body of the safe (VdS approval).
- Diamond core drill (CD) protection: extra EN 1143-1 certification from ECB•S for Grades IV to VI.
- DOCT alarm system with in-built shock, thermal and seismic detection sensors. Available in two levels: standard risk and high risk.

