

**NEW:**  
The Chubb safes Europa provides the highest level of protection for cash and valuables to international standards



# Europa (Grades 3 & 5)

burglary protection

## Key Features

- High quality cash safe protecting cash within an office environment with a high level of security of Grade 3 & 5
- The Europa range is tested to ECB.S and conforming to EN1143-1
- Passive and active relockers are incorporated into the boltwork to resist attack
- Chubb safes special barrier material is applied in the construction of the safe to protect against varying kinds of burglary attack
- Each safe can be equipped with high quality fittings to maximise storage requirements
- The Europa can be customised with a choice of locking options, deposits, shelves and lockable drawer deposits in order to meet customer requirements
- Base fixing is standard on all models



Tested to conform to  
AS/NZS 3809 (Safes and Strongrooms)

Licenc No: SMK20290

**Chubb safes**  
Trusted the world over.

BURGLARY  
RESISTANCE

## Product Specifications

- All Chubb safes' locks are tested to VdS and conform to EN1143-1

The Europa 3 & 5 offer Key Lock with Keyless Combination locking as standard. A wide variety of electronic, time delay locks can be fitted on request.



Electronic Lock



Keylock

## Internal Fittings

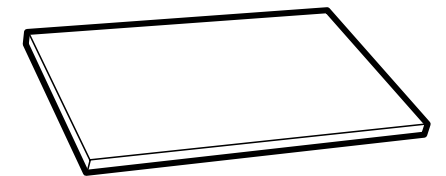
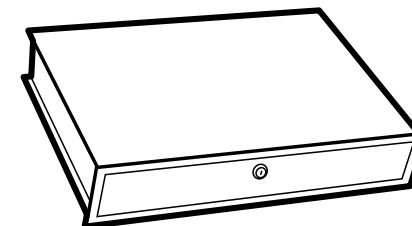
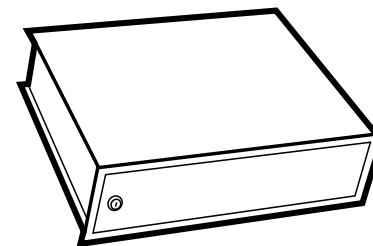

Authorised dealer:

**Chubb safes**  
Trusted the world over.

Gunnebo Security Pty Ltd  
22 South Street, Rydalmere, NSW 2116  
Tel +61 2 8845 0700 Fax +61 2 8845 0731

Email: [info@chubbsafes.com.au](mailto:info@chubbsafes.com.au)

Website: [www.chubbsafes.com.au](http://www.chubbsafes.com.au)

'Chubb' is owned by Chubb plc and is a registered trademark used under license

## Locking Options

### Europa Dimensions

| Grade | Size | External   |           |           | Depth with door at 90° (F) | Width for full access (G) | Internal |           |           | Volume (L) | Net Weight (Kg) |
|-------|------|------------|-----------|-----------|----------------------------|---------------------------|----------|-----------|-----------|------------|-----------------|
|       |      | Height (A) | Width (B) | Depth (C) |                            |                           | Height   | Width (D) | Depth (E) |            |                 |
| III   | 2    | 718        | 668       | 663       | 1277                       | 1232                      | 550      | 500       | 420       | 116        | 565             |
|       | 3    | 1018       | 668       | 663       | 1277                       | 1232                      | 850      | 500       | 420       | 179        | 750             |
|       | 4    | 1208       | 668       | 773       | 1387                       | 1232                      | 1040     | 500       | 530       | 276        | 1010            |
|       | 5    | 1468       | 668       | 773       | 1387                       | 1232                      | 1300     | 500       | 530       | 345        | 1160            |
|       | 6    | 1796       | 903       | 663       | 1510                       | 1680                      | 1628     | 735       | 420       | 503        | 1635            |
| V     | 7    | 1796       | 903       | 773       | 1620                       | 1680                      | 1628     | 735       | 530       | 634        | 1765            |
|       | 2    | 730        | 680       | 663       | 1277                       | 1227                      | 588      | 538       | 444       | 140        | 645             |
| V     | 3    | 1030       | 680       | 663       | 1277                       | 1227                      | 888      | 538       | 444       | 212        | 873             |
|       | 4    | 1220       | 680       | 773       | 1387                       | 1227                      | 1078     | 538       | 554       | 322        | 1107            |
|       | 5    | 1480       | 680       | 773       | 1387                       | 1227                      | 1338     | 538       | 554       | 400        | 1287            |
|       | 6    | 1808       | 915       | 663       | 1510                       | 1697                      | 1666     | 773       | 444       | 572        | 1840            |
|       | 7    | 1808       | 915       | 773       | 1620                       | 1697                      | 1666     | 773       | 554       | 715        | 1968            |

## Installation Guide

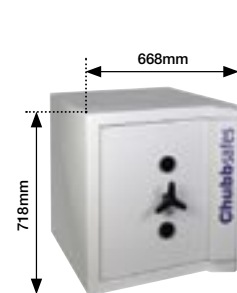
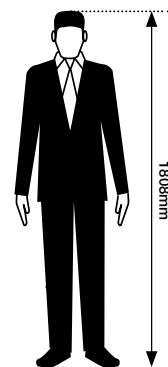
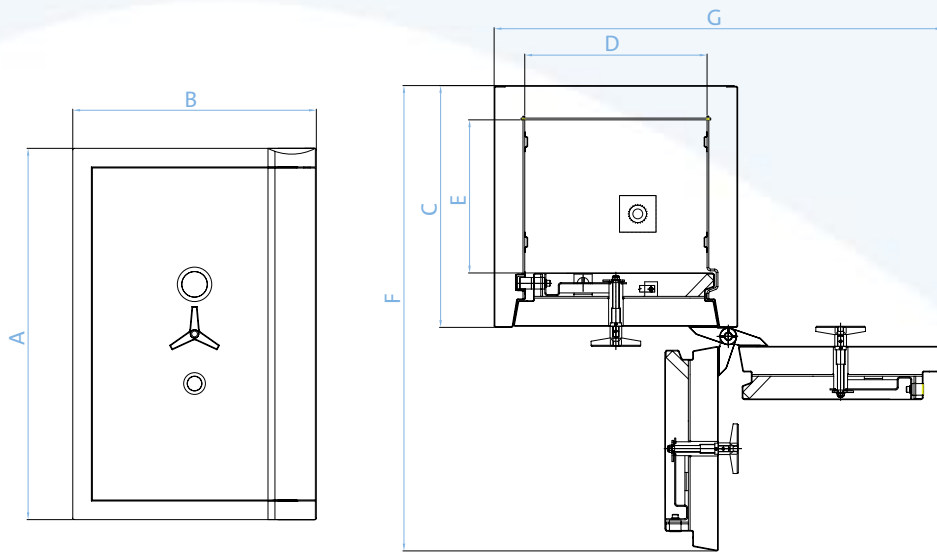

size 2

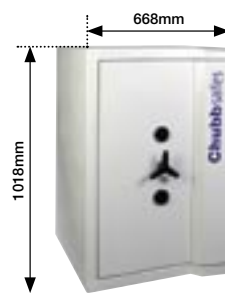

size 3

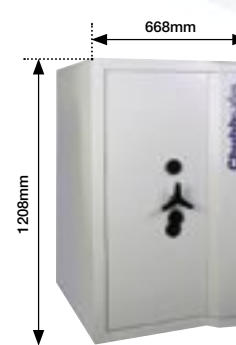

size 4

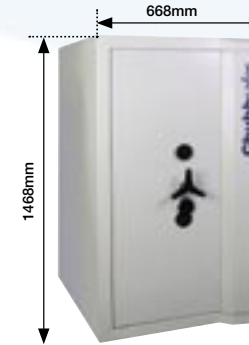

Size 5



size 6



size 7

NB: Fire protection is only available on sizes in Grade I-II

## Testing

A range of attack tools are used in the testing of Chubb safes Europa products from basic tools to the sophisticated tools like oxy-acetylene.



The Europa has been tested to the highest quality in its class against attack.



## Customising

Please ask for further assistance on how we can customise your storage requirements for secure, convenient use.

- Inner compartment as specified by customers



- Prepared to accept pneumatic system for depositing



- Envelope slot with anti-fish device



- Drawer deposit front or rear

